

MH



GENERALITÀ / FEATURES

Elettropompa multistadio orizzontali con giranti in acciaio inox. Utilizzate principalmente in impianti di pressurizzazione, irrigazione, impianti di lavaggio e movimentazione di acqua pulita.

Multistage horizontal electric pumps with impeller of stainless steel. Used in civil application to boost pressure, irrigation, washing plants and pumping of clean water.

MATERIALI / MATERIALS

- Corpo pompa e supporto motore: ghisa
- Giranti: acciaio inox AISI 304
- Diffusori: Noryl®
- Camicia esterna e albero motore: acciaio inox AISI 304
- Tenuta meccanica in ceramica grafite
- Albero: acciaio inox AISI 416

- *Pump casing and motor bracket: cast-iron*
- *Impellers, shell and shaft: stainless steel AISI 304*
- *Diffusers: Noryl®*
- *Ceramic graphite mechanical seal*
- *Shaft: AISI 416 stainless steel*

MOTORE / MOTOR

- Motore chiuso autoventilato
- Protezione: IP44
- Isolamento classe F
- Alimentazione monofase 230V-50Hz, con protezione termica
- Alimentazione trifase 230/400V-50Hz

- *Closed self-ventilated motor*
- *Protection: IP44*
- *Insulation class F*
- *Single-phase feeding: 230V-50Hz with motor protection*
- *Three-phase feeding: 230/400V-50Hz*

LIMITI DI IMPIEGO / OPERATING CONDITIONS

- Temperatura massima del liquido pompato: 35°C
- Pressione massima d'esercizio: 9 bar

- *Max. temperature pumped liquid: 35°C*
- *Max. working pressure: 9 bar*

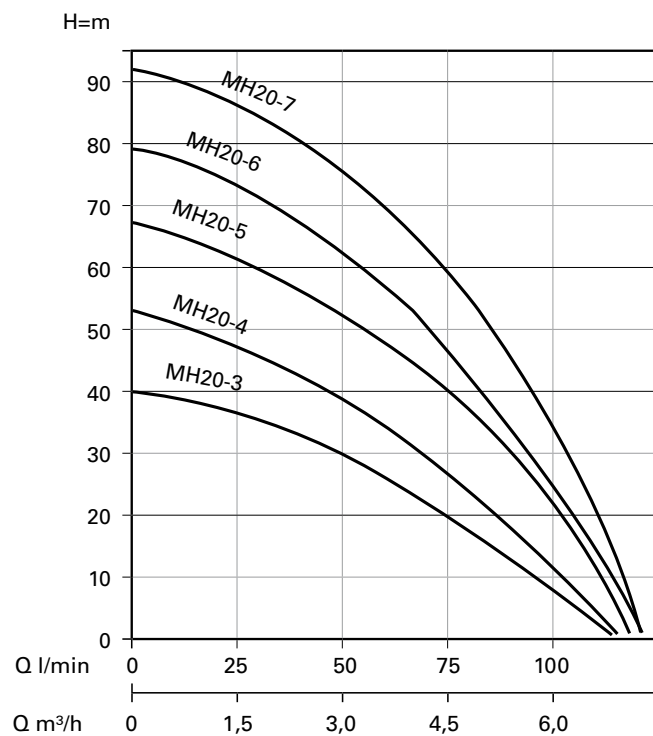
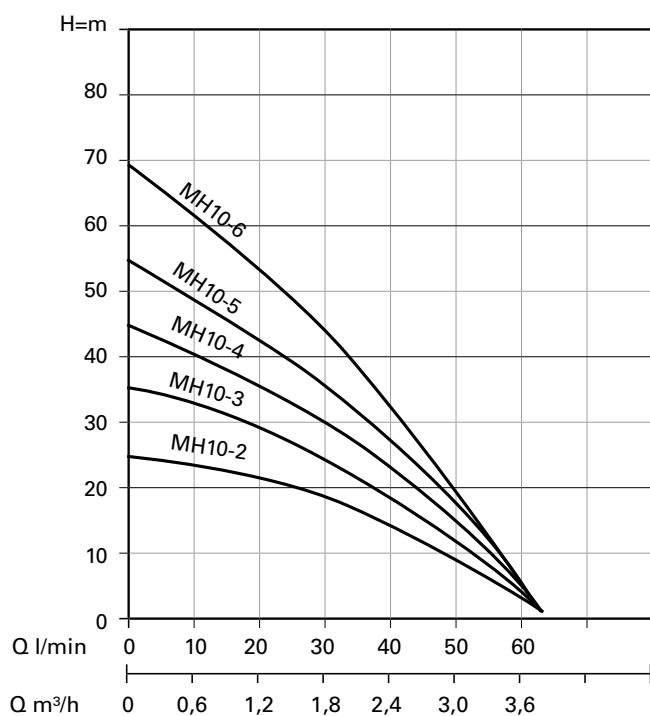

CARATTERISTICHE TECNICHE A 2900 GIRI / TECHNICAL PERFORMANCE AT 2900 RPM

Modello Model		P2		A		Q=Portata - Capacity						
						m³/h 0	0,6	1,2	1,8	2,4	3	3,9
						l/min 0	10	20	30	40	50	65
1~	3~	HP	kW	1x230V	3x400V	Prevalenza manometrica totale in m C.A. Total head in meters w.c.						
MH10-2	MH10-2T	0,5	0,37	2,2	1,1	21	20	18	15	12	7	1
MH10-3	MH10-3T	0,5	0,37	2,6	1,2	32	30	27	23	18	11	1
MH10-4	MH10-4T	0,8	0,6	3,45	1,4	40	37	33	28	22	14	1
MH10-5	MH10-5T	0,8	0,6	3,9	1,6	50	46	41	34	26	17	1
MH10-6	MH10-6T	1,2	0,9	4,9	1,9	60	55	49	41	31	20	1

Modello Model		P2		A		Q=Portata - Capacity							
						m³/h 0	0,9	1,2	1,8	2,4	3	4,5	5,7
						l/min 0	15	20	30	40	50	75	95
1~	3~	HP	kW	1x230V	3x400V	Prevalenza manometrica totale in m C.A. Total head in meters w.c.							
MH20-3	MH20-3T	1	0,75	4,2	1,8	39,5	39	38	35	33	29	19	10
MH20-4	MH20-4T	1,1	0,8	5,4	2,3	52	49,5	48	49	43	39	27	15
MH20-5	MH20-5T	1,6	1,2	7,2	2,8	67	64	63	59	56	51	39	24
MH20-6	MH20-6T	1,6	1,2	7,8	3,5	78	75	74	71	67	62	46	29
MH20-7	MH20-7T	2	1,5	8,6	3,8	91	87	86	84	80	75	59	39

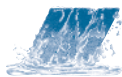

MH

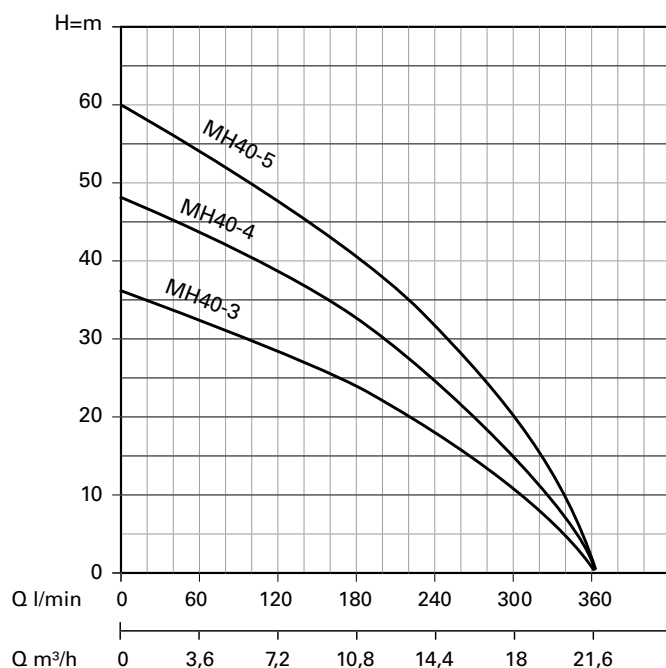
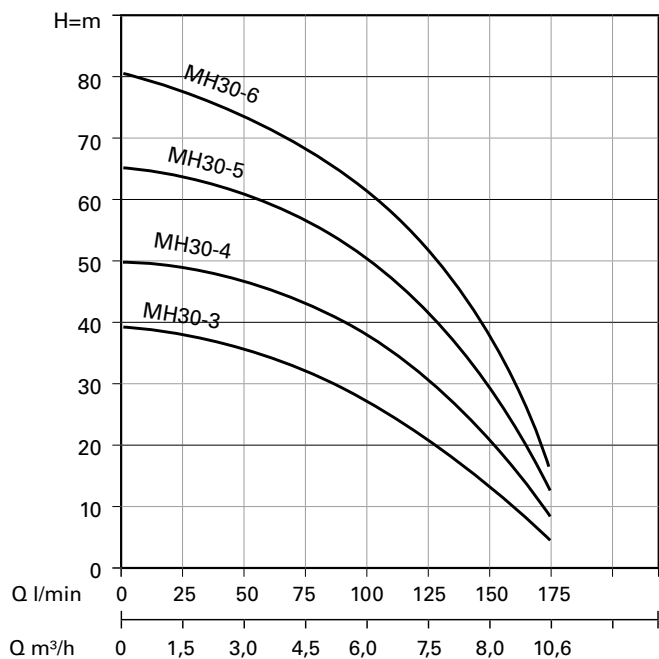

CARATTERISTICHE TECNICHE A 2900 GIRI / TECHNICAL PERFORMANCE AT 2900 RPM

Modello Model		P2		A		Q=Portata - Capacity									
						m³/h 0	1,2	1,8	2,4	3	4,5	6	7,5	9	10,5
1~	3~	HP	kW	1x230V	3x400V	l/min 0	20	30	40	50	75	100	125	150	175
						Prevalenza manometrica totale in m C.A. Total head in meters w.c.									
MH30-3	MH30-3T	1,2	0,9	7	3,3	40	39	38	37	36	32	27	21	13	4,5
MH30-4	MH30-4T	1,5	1,1	9	3,5	52	49	48,5	48	47	43	38	30	20	7,5
MH30-5	MH30-5T	2	1,5	11,8	4,2	66	65	64	63	62	57	50	41	28	11
MH30-6	MH30-6T	3	2,2	12,4	5	81	79,5	78	76	75	69	61	50	36	14,5

Modello Model		P2		A		Q=Portata - Capacity									
						m³/h 0	4,8	6	7,2	9	10,8	13,2	15	18	21
1~	3~	HP	kW	1x230V	3x400V	l/min 0	80	100	120	150	180	220	250	300	350
						Prevalenza manometrica totale in m C.A. Total head in meters w.c.									
MH40-3	MH40-3T	3	2,2	11	3,6	40	34	30	28	26	24	19	15	10	2
MH40-4	MH40-4T	3	2,2	12	4,2	50	46	42	38	36	34	26	25	15	3
	MH40-5T	4	3		6	58	55	48	45	42	40	35	31	20	4

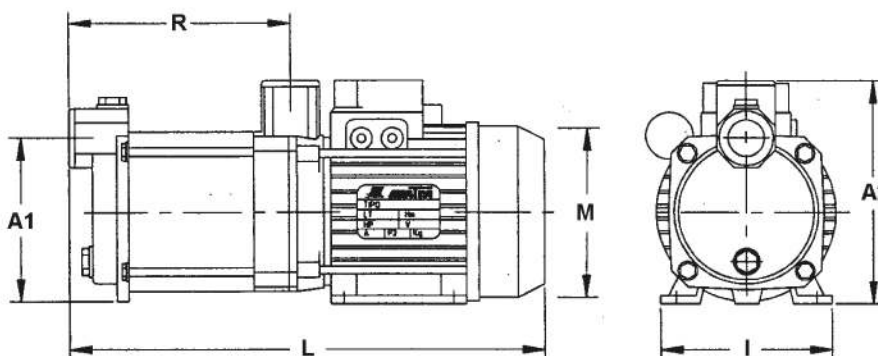
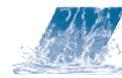

MODELLO POMPA PUMP'S MODEL	DIMENSIONI POMPA mm PUMP'S DIMENSIONS mm								PESO WEIGHT kg
	A1	A2	R	I	L	M	DNA	DNM	
MH 10-2	108	147	128,5	155	320	165	1" G	1" G	8
MH 10-3	108	147	157	155	338	165	1" G	1" G	8,3
MH 10-4	108	147	179	155	355	165	1" G	1" G	8,5
MH 10-5	108	147	204	155	373	165	1" G	1" G	9
MH 10-6	108	147	229	155	400	165	1" G	1" G	9,2
MH 20-3	138	171	176	170	400	193	1" G	1" G	13
MH 20-4	137	171	205	170	424	193	1" G	1" G	13,5
MH 20-5	137	171	234	170	448	193	1" G	1" G	14
MH 20-6	137	171	263	170	472	193	1" G	1" G	14,5
MH 20-7	137	171	292	170	496	193	1" G	1" G	16
MH 30-3	160	190	202	188	447	215	1" 1/4 G	1" 1/4 G	17
MH 30-4	160	190	236	188	475	215	1" 1/4 G	1" 1/4 G	17,5
MH 30-5	160	190	269	188	503	215	1" 1/4 G	1" 1/4 G	19
MH 30-6	160	190	303	188	531	215	1" 1/4 G	1" 1/4 G	20
MH 40-3	160	200	250	170	500	200	1" 1/2 G	1" 1/2 G	20
MH 40-4	160	200	290	171	540	200	1" 1/2 G	1" 1/2 G	22
MH 40-5	160	200	325	170	610	200	1" 1/2 G	1" 1/2 G	26